



Branche Connecteurs Offshore



### *9316 series*

- Underwater applications
- Explosion proof
- Hermetically sealed

1	<i>Introduction</i>
2	<i>Presentation</i>
3	<i>Technical characteristics</i>
4	<i>Synopsis</i>
5	<i>Part-numbering system</i>
6-7	<i>Arrangements</i>
7	<i>Mechanical keyway</i>
8	<i>Hermetic receptacles</i>
9	<i>Plugs</i>
9-10	<i>Protective caps</i>
11	<i>Accessories</i>
12	<i>Mating and unmating dimensions - Mounting style</i>
13	<i>Thermo-shrink sleeves - Gaskets</i>
14-15	<i>Contacts and tooling</i>

## General points

The DEUTSCH 9316 series has been designed to withstand the most severe environments in marine and off-shore applications down to 1500 or 7500 metres underwater.

A special care was taken concerning :

- Easy handling,
- Mechanical stress,
- Use in polluted environments.
- Use in hazardous areas.

We have particularly studied the mechanical strength, the elastomers selection and the suitability of the accessories for the most commonly used cables.

This series benefits from advanced technologies in glass to metal sealing and resistance to high pressures.

The 9316 series cover most requirements for on board or underwater use :

- Signal, control
- High frequency,
- Medium and high power.

To guarantee the quality of these products, DEUTSCH is equipped with conventional and special testing facilities dedicated to :

- Mechanical resistance,
- Ageing,
- Helium test,
- High pressure test.

Also, a specialized team is at customers disposal to study and achieve the wiring and testing of the 9316 connectors in our facilities or on site.

## Application

The 9316 connectors have been designed for signal or power links down to 7500 meters and in explosive environments.

They are available in the following types :

- Hermetically sealed receptacles and feedthru's,
- Explosion-proof (as per EN 50014).
- Waterproof, 150 bars (2175 psi) - 9316 series, (hermetic receptacles only)
- Waterproof, 750 bars (10875 psi) - 9306 series, (Consult us)

## Typical applications

- Underwater control systems,
- Wellheads
- Submarines,
- ROV,
- Platforms,
- Loading buoys,
- Mines.

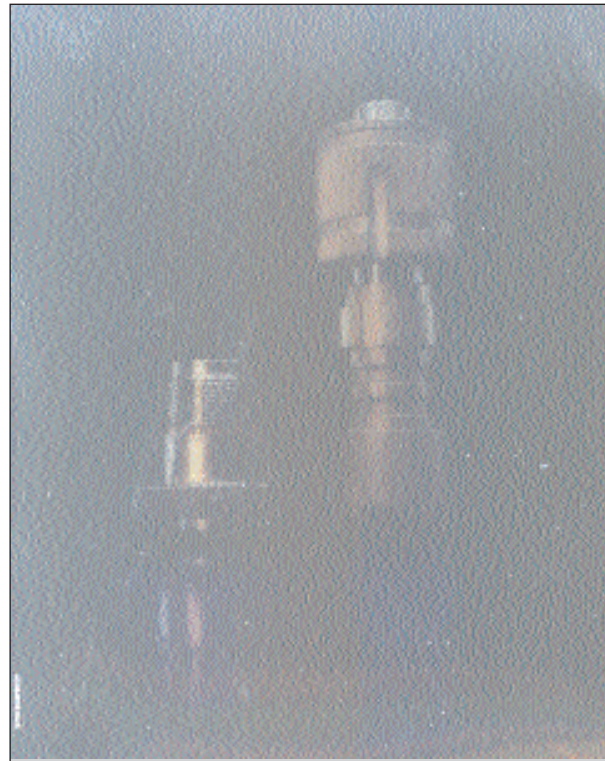

## ■ Design features

The shells are made of stainless steel. The coupling rings are made of marine bronze. In all cases, connectors in the 9316 series are scoop-proof ; a keying system is available in each size. The inserts include one part in thermo-setting plastic, and two parts in rubber silicone. Contacts are crimp type (except for hermetic connectors and some power arrangements). Hermetic receptacles and feedthru's are fitted with ferro-nickel contacts sealed into a glass disc. They are plated with gold over nickel. The hermetic connectors withstand the pressure given in both directions (safety factor : 2P). Sealing of all hermetic connectors is tested by heli-test.

## ■ Explosion-Proof connectors

The 9316 series (see shell types certified pages 4 and 5) meet the requirements of the relevant European standard EN 50014, EN 50018 and have received the following agreement :

L.C.I.E. certificate n° 98.E0009 U.  
 Protection mode : Explosion-Proof envelope (EN 50018),  
 Gas group : Groupe II B,  
 Temperature class : T6 (layout 121-901, see note page 7).

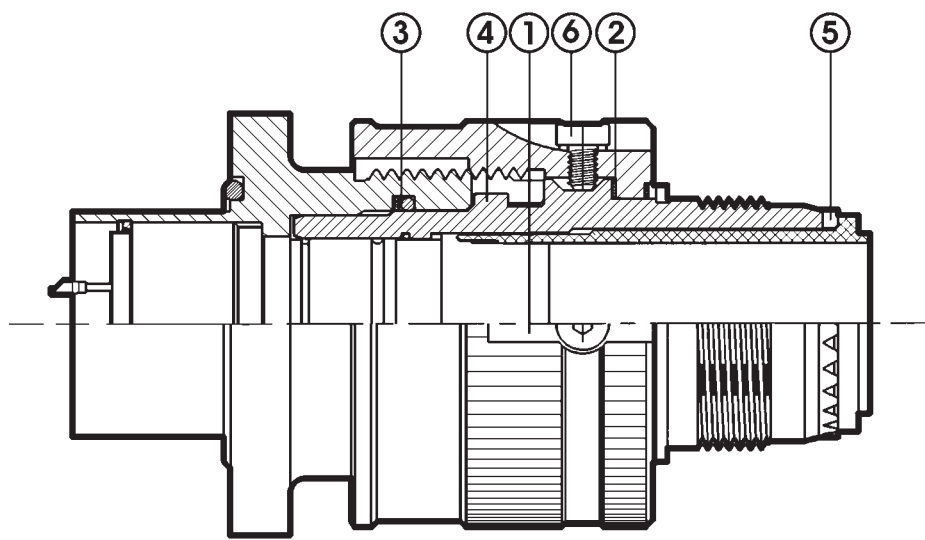

- 1 Coupling ring to be tightened with a spanner,
- 2 Anti-friction washer allowing a constant coupling torque,
- 3 Plug/receptacle sealing granted by o'ring and anti-extrusion gasket,
- 4 Shell keying system,
- 5 Anti-rotation system with teeth at the rear of the plug, allowing a secure tightening and clamping of the accessories,
- 6 Rotation blocking screws after mating

### ■ Mechanical

Shell	: Stainless steel AISI 316 L passivated
Coupling ring	: Marine bronze UA9 NFE-C 321
Insert (plug/in line receptacle)	: Thermo-setting resin, silicone elastomer These inserts meet requirements of MIL-H 5606
Insert (hermetic receptacle)	: Glass
Contact (plug/in line receptacle)	: Crimp type # 20, 16, 12 and coax : rear insertion and front extraction Crimp type and solder type size 8 Crimp, solder or terminal type size 6, 4, 0, 150 mm <sup>2</sup> , 300 mm <sup>2</sup>
Contact (hermetic receptacle)	: Iron nickel (or copper, mode A810), solder or terminal (size 0, 150 mm <sup>2</sup> )
Protection	: Gold over nickel
Endurance	: 500 mating and unmating cycles
Contact retention force	: After 10 insertion and extraction operations : Size 20 : 7 daN mini Size 16, 12, 8 : 11,2 daN mini
Hermeticity	: Individual heli-test ; leakage inferior to 0,28 mm <sup>3</sup> /hour at 1 bar differential pressure

### ■ Climatics

Working temperature	: Standard connectors : -55° C to + 125° C Explosion proof connectors : -55° C to + 85° C
---------------------	--

### ■ Electrical

Dielectric withstanding voltage	
At sea level	: Service 1 : 1500 V A.C. Service 2 : 2300 V A.C. Power : see page 7
Insulation resistance	: Superior to 5000 MΩ at 25° C and 65 % relative humidity
Maximum current rating per contact	: Size 20 : 5 A. max.           Size 4   : 60/100 A. max. Size 16 : 10 A. max.        Size 0   : 120/200 A. max. Size 12 : 17 A. max.        150 mm <sup>2</sup> : 400 A. max. Size 8 : 33 A. max.         300 mm <sup>2</sup> : 600 A. max.

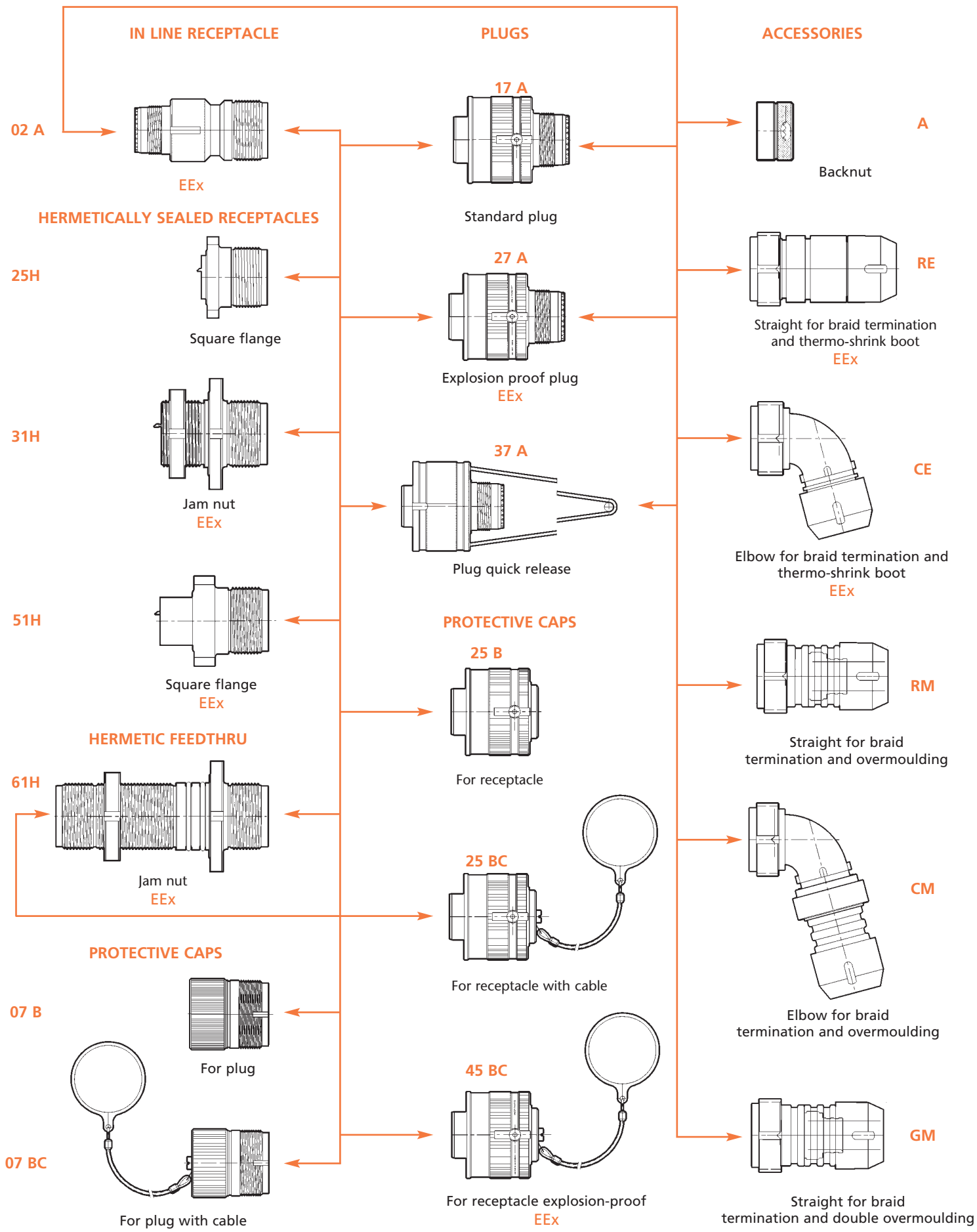

## 9316 - 27 A 19 - 12 PN \* \*\*\*

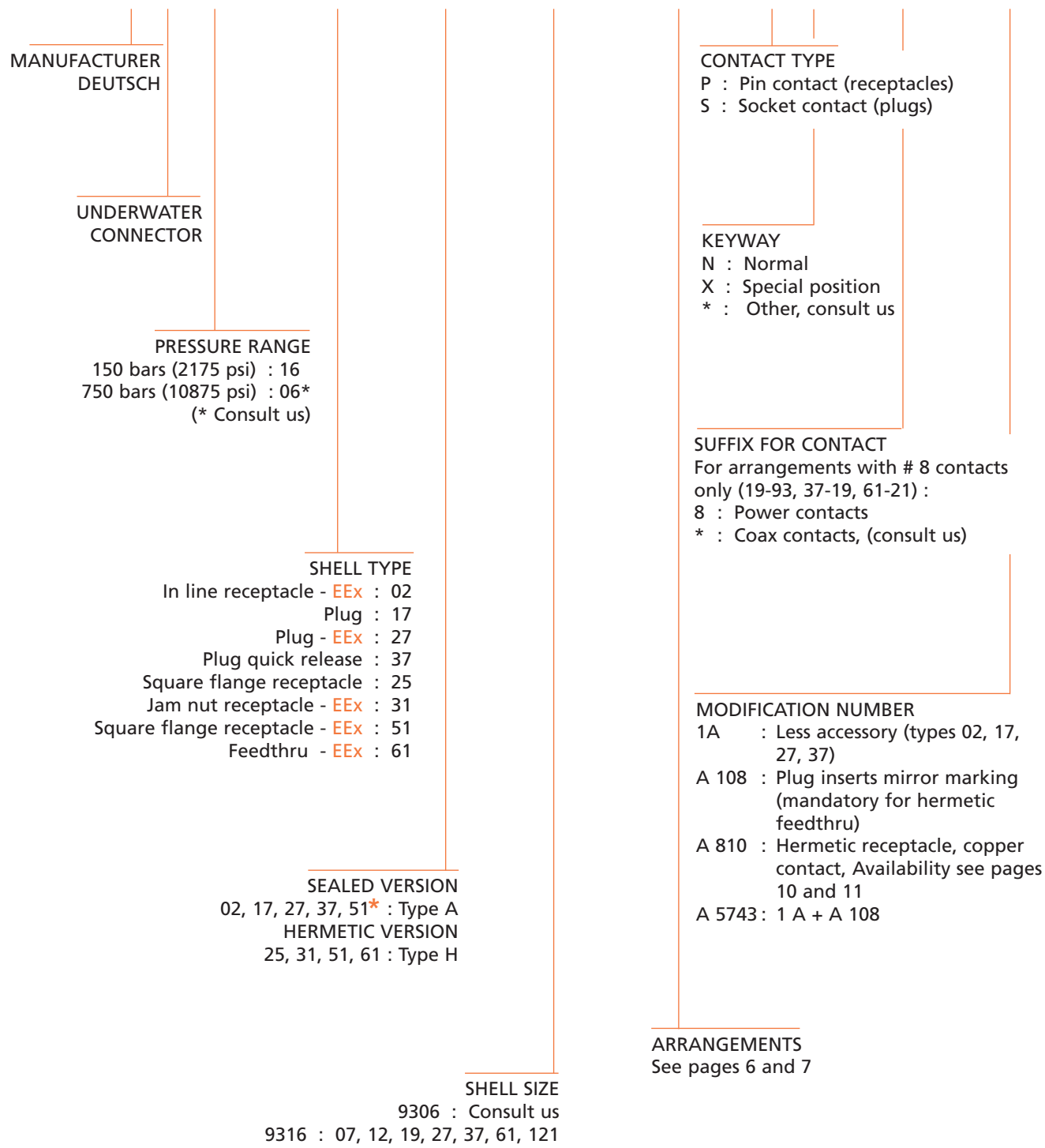

\* : Arrangements 121-901 and 121-905

Male insert receptacle front view or female insert plug, wiring side view.

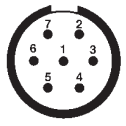

**Arrangement 07-0**  
7 contacts size 20  
Service 1

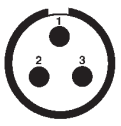

**Arrangement 07-93**  
3 contacts size 16  
Service 2

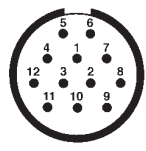

**Arrangement 12-0**  
12 contacts size 20  
Service 1

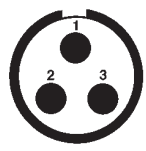

**Arrangement 12-93**  
3 contacts size 12  
Service 2

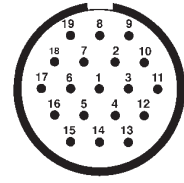

**Arrangement 19-0**  
19 contacts size 20  
Service 1

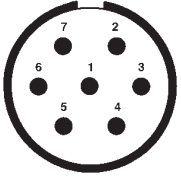

**Arrangement 19-7**  
7 contacts size 12  
Service 2

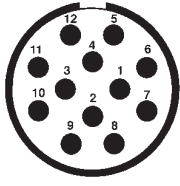

**Arrangement 19-12**  
12 contacts size 16  
Service 1

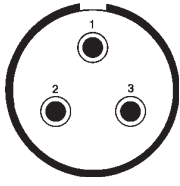

**Arrangement 19-93**  
3 contacts size 8 or coax  
Service 2

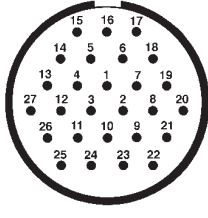

**Arrangement 27-0**  
27 contacts size 20  
Service 1

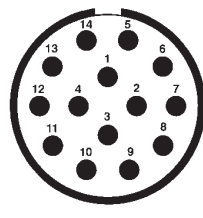

**Arrangement 27-2**  
14 contacts size 16  
Service 2

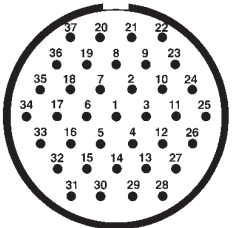

**Arrangement 37-0**  
37 contacts size 20  
Service 1

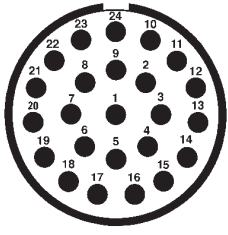

**Arrangement 37-2**  
24 contacts size 16  
Service 1

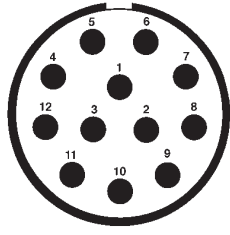

**Arrangement 37-3**  
12 contacts size 12  
Service 1

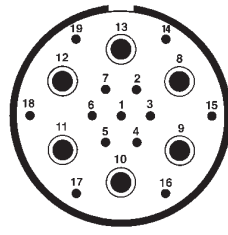

**Arrangement 37-19**  
13 contacts size 20  
6 contacts size 8 or coax  
Service 1

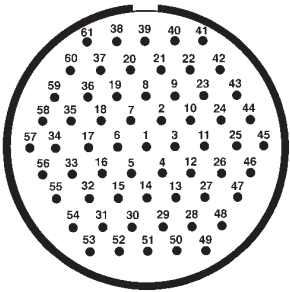

**Arrangement 61-0**  
61 contacts size 20  
Service 1

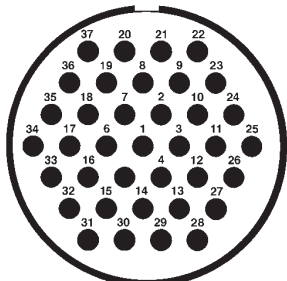

**Arrangement 61-14**  
37 contacts size 16  
Service 1

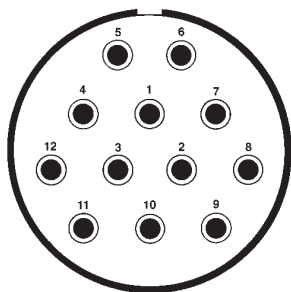

**Arrangement 61-21**  
12 contacts size 8 or coax  
service 1

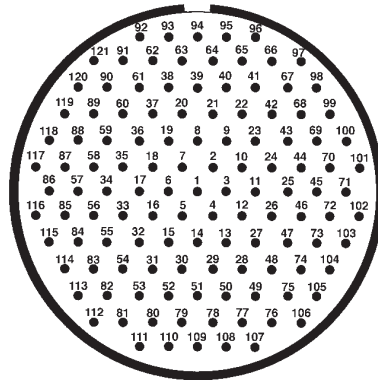

**Arrangement 121-0**  
121 contacts size 20  
Service 1

Service 1 : Service voltage 250 VAC  
Service 2 : Service voltage 650 VAC



Male insert viewed from front face or female insert, wiring side view.

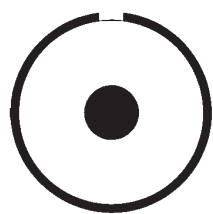

**Arrangement 27-901 ▲**  
1 contacts size 0

Version	Rating	Service	
A Sealed	3500 VRMS	1250 VAC	200 A
H Hermetic	3500 VRMS	1250 VAC	120 A
H... A810 Hermetic	2500 VRMS	750 VAC	200 A

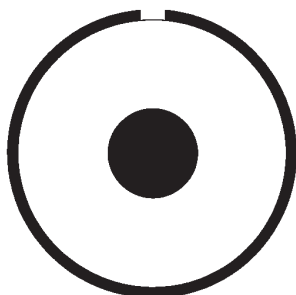

**Arrangement 61-901 ●**  
1 x 150 mm<sup>2</sup>

Version	Rating	Service	
A Sealed	5000 VRMS	2000 VAC	400 A
H Hermetic	Not available		
H... A810 Hermetic	5000 VRMS	2000 VAC	400 A

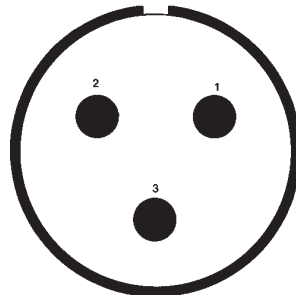

**Arrangement 61-903 ▲**  
3 contacts size 4

Version	Rating	Service	
A Sealed	3500 VRMS	1250 VAC	100 A
H Hermetic	3500 VRMS	1250 VAC	60 A
H... A810 Hermetic	2500 VRMS	750 VAC	100 A

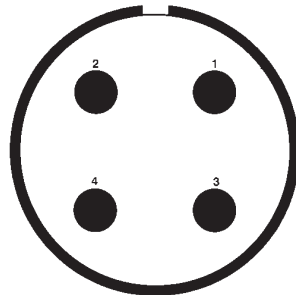

**Arrangement 61-904**  
4 contacts size 4

Version	Rating	Service	
A Sealed	3500 VRMS	1250 VAC	100 A
H Hermetic	3500 VRMS	1250 VAC	60 A
H... A810 Hermetic	Not available		

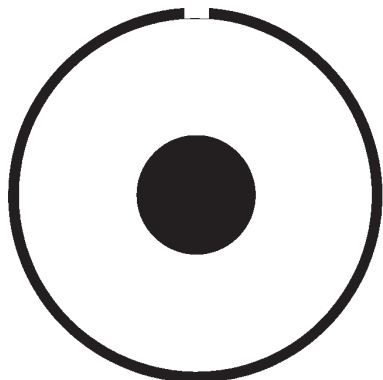

**Arrangement 121-901 \***  
1 x 300m<sup>2</sup>

Version	Rating	Service	
A Sealed	5000 VRMS	2000 VAC	600 A
H Hermetic	Not available		
H... A810 Hermetic	Not available		

EExd T5 for current ≤ 600 A

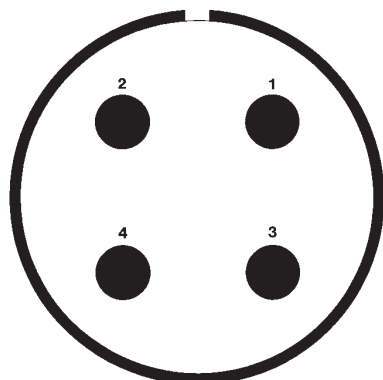

**Arrangement 121-904 ▲**  
4 contacts size 0

Version	Rating	Service	
A Sealed	3500 VRMS	1250 VAC	200 A
H Hermetic	Not available		
H... A810 Hermetic	2500 VRMS	750 VAC	200 A

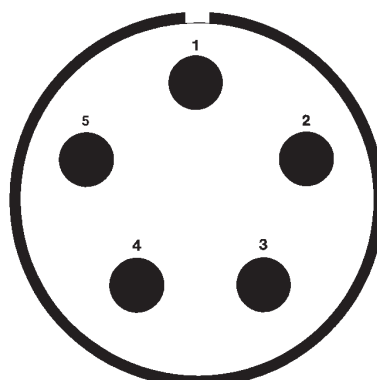

**Arrangement 121-905 \***  
5 contacts size 4

Version	Rating	Service	
A Sealed	3000 VRMS	1000 VAC	100 A
H Hermetic	Not available		
H... A810 Hermetic	Not available		

\* Hermetic receptacles not available

● Modification A 810 (Hermetic, copper contact) only available

▲ Modification A 810 (Hermetic, copper contact), available.

Nota : Voltage rating is test voltage. Other arrangements, consult us.

## Mechanical keyway

Receptacle front view

U - V - W - Y - Z : Available for some other shell sizes, please consult us..

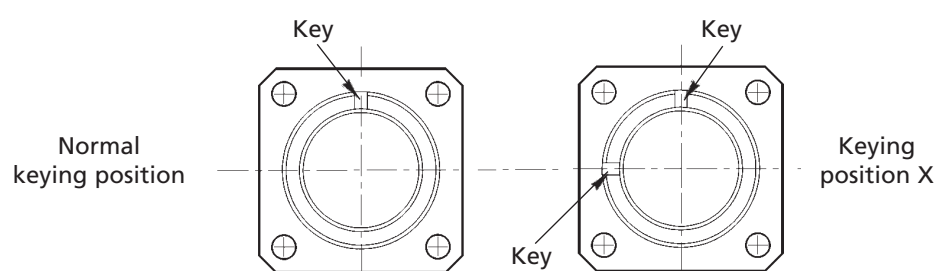

## ■ Square flange - TYPES 25H - 51H

TYPE 25H

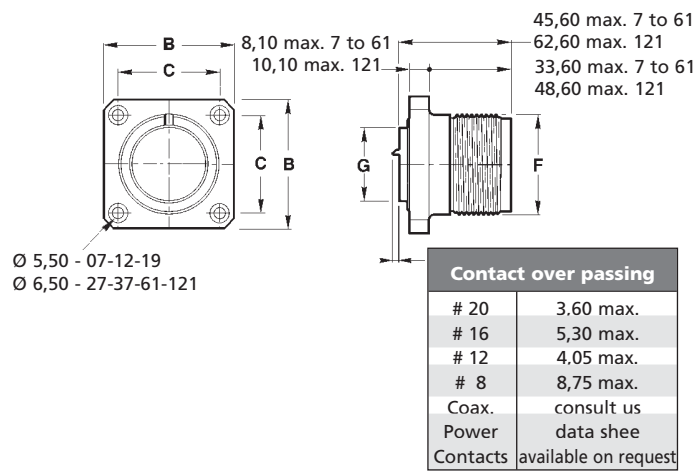

TYPE 51H

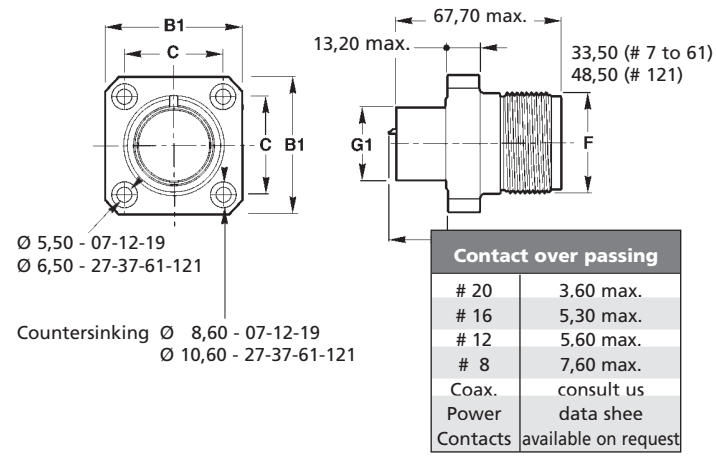

Reference	B max.	B1 MAX.	C	F	G max.	G 1	Reference
9316-25H 07-**-P*	38,50	41,50	29,00	29	20,00	20,00	9316-51H 07-**-P*
9316-25H 12-**-P*	39,50	42,50	30,00	31	23,00	23,00	9316-51H 12-**-P*
9316-25H 19-**-P*	41,50	44,50	32,00	34	26,00	26,00	9316-51H 19-**-P*
9316-25H 27-**-P*	53,50	56,50	40,00	41	30,00	30,00	9316-51H 27-**-P*
9316-25H 37-**-P*	57,50	60,50	44,00	46	34,50	34,50	9316-51H 37-**-P*
9316-25H 61-**-P*	62,50	65,50	49,00	53	43,50	43,50	9316-51H 61-**-P*
9316-25H 121-**-P*	73,50	73,50	60,00	67	55,00	55,00	9316-51H 121-**-P*

## ■ Jam nut - TYPES 31H - 61H

TYPE 31H

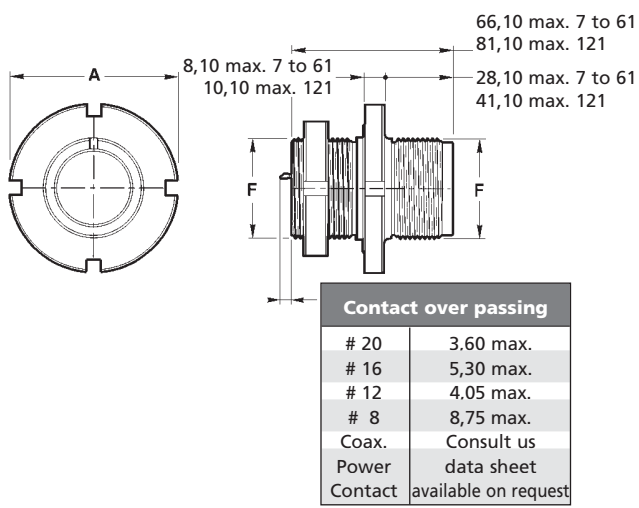

TYPE 61H

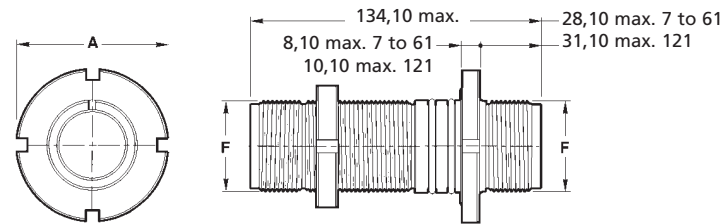

Reference	A max.	F	Reference
9316-31H 07-**-P*	51,00	29	9316-61H 07-**-PP*
9316-31H 12-**-P*	52,00	31	9316-61H 12-**-PP*
9316-31H 19-**-P*	55,00	34	9316-61H 19-**-PP*
9316-31H 27-**-P*	69,00	41	9316-61H 27-**-PP*
9316-31H 37-**-P*	74,00	46	9316-61H 37-**-PP*
9316-31H 61-**-P*	80,00	53	9316-61H 61-**-PP*
9316-31H 121-**-P*	95,00	67	9316-61H 121-**-PP*

## ■ In line receptacle -TYPE 02A

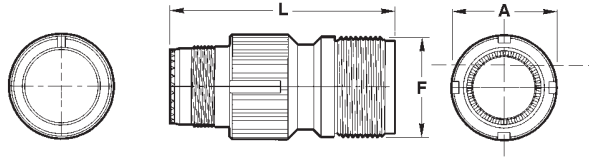

Reference	A max.	L max.	F
9316-02 A 07-** P* 1A	31,20	92,50	29
9316-02 A 12-** P* 1A	33,20	92,50	31
9316-02 A 19-** P* 1A	36,20	92,50	34
9316-02 A 27-** P* 1A	43,20	92,50	41
9316-02 A 37-** P* 1A	48,20	92,50	46
9316-02 A 61-** P* 1A	55,20	92,50	53
9316-02 A 121-** P* 1A	69,20	122,50	67

## ■ Plugs - TYPES 17A - 27A - 37A

STANDARD  
17A

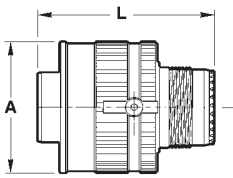

EXPLOSION-PROOF  
27A

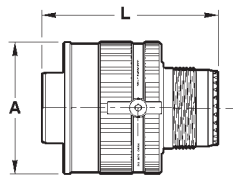

QUICK RELEASE  
37A

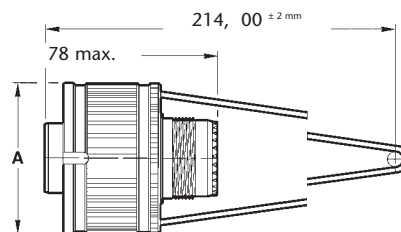

Reference	A max.	A1 max.	L max.
9316 ** A 07-** S* 1A	42,20	51,00	72,20
9316 ** A 12-** S* 1A	44,20	53,00	72,20
9316 ** A 19-** S* 1A	47,20	56,00	72,20
9316 ** A 27-** S* 1A	54,20	63,00	72,20
9316 ** A 37-** S* 1A	59,20	68,00	72,20
9316 ** A 61-** S* 1A	66,20	75,00	72,20
9316 ** A 121-** S* 1A	80,20	88,00	87,20

■ Cap for plug - TYPES 07 B - 07 BC

WITHOUT FASTENING CABLE  
07 B

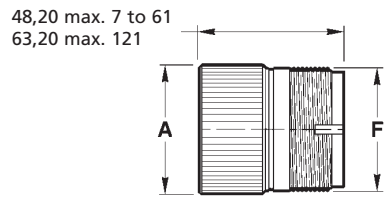

WITH FASTENING CABLE  
07 BC

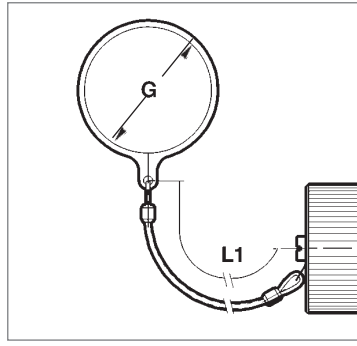

Reference	A max.	F	G mini.	L1 max.	Reference
9316-07 B 07	31,20	29	22,50	200	9316-07 BC 07
9316-07 B 12	33,20	31	25,50	200	9316-07 BC 12
9316-07 B 19	36,20	34	28,90	200	9316-07 BC 19
9316-07 B 27	43,20	41	33,70	200	9316-07 BC 27
9316-07 B 37	48,20	46	36,80	200	9316-07 BC 37
9316-07 B 61	55,20	53	44,50	200	9316-07 BC 61
9316-07 B 121	69,20	67	58,10	200	9316-07 BC 121

■ Cap for receptacle - TYPES 25 B - 25 BC

WITHOUT FASTENING CABLE  
25 B

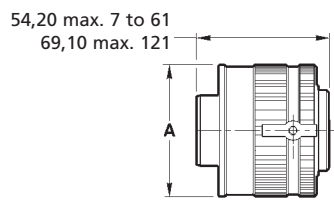

WITH FASTENING CABLE  
25 BC

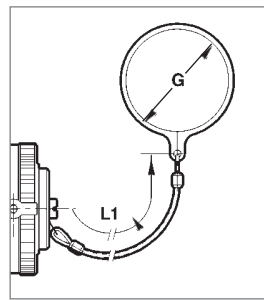

Reference	A max.	G mini.	L1 max.	Reference
9316-25 B 07	42,20	30,40	200	9316-25 BC 07
9316-25 B 12	44,20	32,00	200	9316-25 BC 12
9316-25 B 19	47,20	34,80	200	9316-25 BC 19
9316-25 B 27	54,20	41,60	200	9316-25 BC 27
9316-25 B 37	59,20	47,80	200	9316-25 BC 37
9316-25 B 61	66,20	55,40	200	9316-25 BC 61
9316-25 B 121	80,20	71,20	200	9316-25 BC 121

■ Explosion-proof cap for receptacle - TYPE 45 BC

WITH FASTENING CABLE

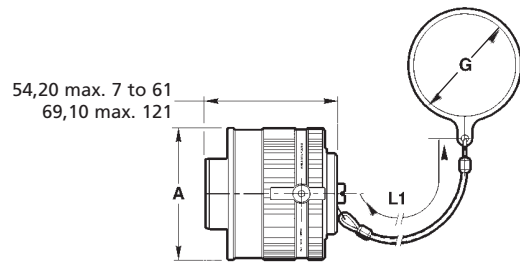

Reference	A max.	G mini.	L1 max.
9316-45 BC 07	42,20	30,40	200
9316-45 BC 12	44,20	32,00	200
9316-45 BC 19	47,20	34,80	200
9316-45 BC 27	54,20	41,60	200
9316-45 BC 37	59,20	47,80	200
9316-45 BC 61	66,20	55,40	200
9316-45 BC 121	80,20	71,20	200

### Backnut

Reference	G	L1	R
	max.	mini.	max.
087-0004-07	24,50	4,80	72,20
087-0004-12	27,10	4,80	72,20
087-0004-19	30,80	4,80	72,20
087-0004-27	35,55	4,80	72,20
087-0004-37	38,70	4,80	72,20
087-0004-61	45,90	4,80	72,20
087-0004-95	56,90	4,80	87,20

Tightening torque. mN
20
22
25
28
32
37
45

\* Valid for all types, all nuts

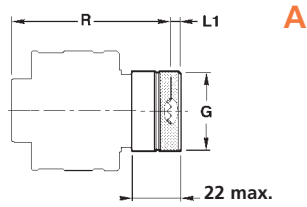

### Straight for braid termination and thermo shrink boot

Reference	G	J	L	L1	P	R
	max.	mini.	max.	max.	max.	max.
640-0336-07	34,90	16,45	88,70	70,95	30,45	72,20
640-0336-12	37,80	19,25	88,70	70,95	33,45	72,20
640-0336-19	42,60	22,25	88,70	70,95	36,95	72,20
640-0336-27	45,80	27,75	91,90	73,95	41,85	72,20
640-0336-37	53,80	31,05	91,90	73,95	45,15	72,20
640-0336-61	57,40	38,45	95,00	77,05	53,15	72,20
640-0336-95	69,70	45,30	115,00	96,15	60,60	87,20

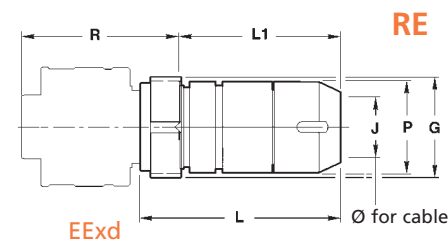

### Elbow for braid termination and thermo shrink boot

Reference	G	J	L	L1	P	R	T
	max.	mini.	max.	max.	max.	max.	max.
640-0334-07	34,90	15,75	63,50	45,75	28,40	72,20	61,15
640-0334-12	37,80	18,55	66,20	48,45	31,20	72,20	62,20
640-0334-19	42,60	22,35	69,80	52,05	34,30	72,20	65,35
640-0334-27	45,80	24,90	74,80	57,05	38,30	72,20	67,55
640-0334-37	53,80	29,50	78,10	60,35	42,30	72,20	68,00
640-0334-61	57,40	37,40	85,35	67,60	49,40	72,20	72,10
640-0334-95	*	*	*	*	*	*	*

\* Consult us

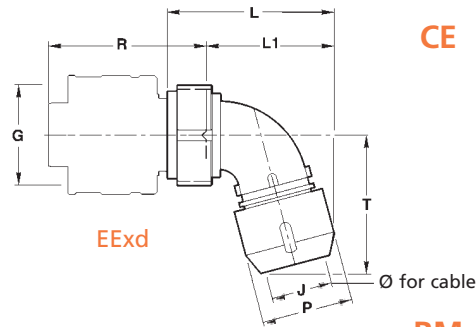

### Straight for braid termination and overmoulding

Reference	G	J	L	L1	P	R
	max.	mini.	max.	max.	max.	max.
640-0337-07	34,90	16,45	72,00	54,25	30,30	72,20
640-0337-12	37,80	19,25	72,00	54,25	33,30	72,20
640-0337-19	42,60	22,25	72,00	54,25	36,30	72,20
640-0337-27	45,80	27,75	72,00	54,25	41,70	72,20
640-0337-37	53,80	31,05	72,00	54,25	45,00	72,20
640-0337-61	57,40	38,45	72,00	54,25	53,00	72,20
640-0337-95	69,70	45,30	86,00	67,00	60,60	87,20

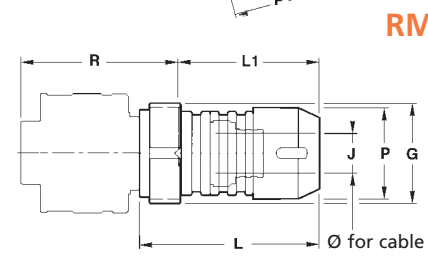

### Elbow for braid termination and overmoulding

Reference	G	J	L	L1	P	R	T
		mini.	max.	max.	max.	max.	max.
640-0335-07	34,90	16,45	73,45	56,00	30,30	72,20	96,50
640-0335-12	37,80	19,25	76,40	58,95	33,30	72,20	98,05
640-0335-19	42,60	22,25	79,80	62,35	36,80	72,20	99,80
640-0335-27	45,80	27,75	85,45	67,80	41,70	72,20	102,95
640-0335-37	53,80	31,05	88,65	71,00	45,00	72,20	106,60
640-0335-61	57,40	38,45	96,35	78,70	53,00	72,20	108,60
640-0335-95	*	*	*	*	*	*	*

\* Consult us

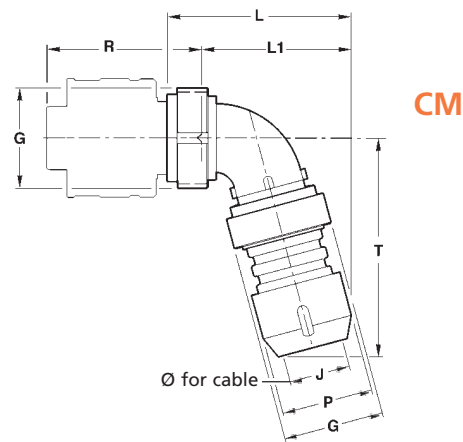

### Straight for braid termination and double overmoulding

Reference	G	J	J1	L	L1	P	R
	max.	mini.	max.	max.	max.	max.	max.
640-0180-07	34,90	16,45	10,80	85,20	67,25	30,30	72,20
640-0180-12	37,80	19,25	12,80	85,20	67,25	33,30	72,20
640-0180-19	42,60	22,25	14,80	85,20	67,25	36,80	72,20
640-0180-27	45,80	27,75	17,80	85,20	67,45	41,70	72,20
640-0180-37	53,80	31,05	19,80	85,20	67,45	45,00	72,20
640-0180-61	57,40	38,45	22,80	85,20	67,45	53,00	72,20
640-0180-95	*	*	*	*	*	*	*

\* Consult us

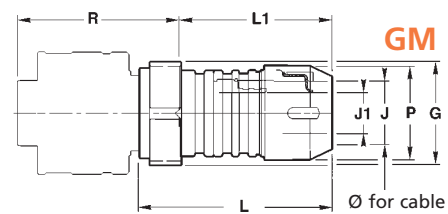

Size	K max.
7 to 61	33,20
121	48,20

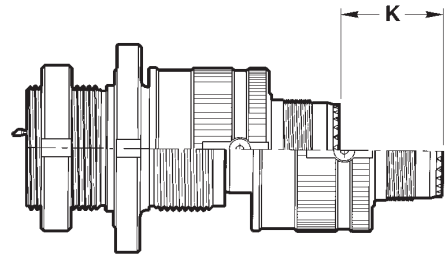

MATED

UNMATED

Size	07	12	19	27	37	61	121
Tightening torque mN	50	55	60	60	70	80	110

## ■ Square flange receptacle - TYPES 25 - 51 H

IMPORTANT NOTE : The surface roughness on the equipments, should be 0.4 - 0.8 micron.  
A bearing face of 1.6 micron max. is tolerated.

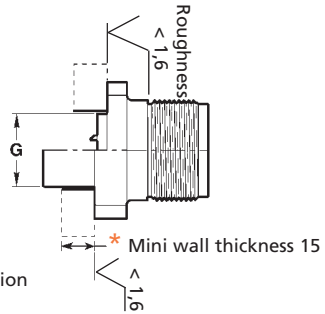

\* for explosion-proof application

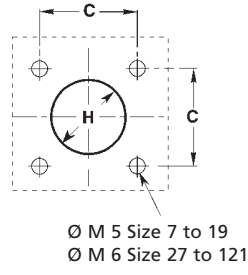

Ø M 5 Size 7 to 19  
Ø M 6 Size 27 to 121

Size	C $\pm 0,10$	G max.	H	
			25H $+0$ $-0,2$	51H $+0,075$ $-0$
07	29,00	20,00	20,40	20,00
12	30,00	23,00	23,40	23,00
19	32,00	26,00	26,40	26,00
27	40,00	30,00	30,40	30,00
37	44,00	34,50	34,90	34,50
61	49,00	43,50	43,90	43,50
121	60,00	55,00	55,40	55,00

## ■ Jam nut receptacle and feedthru - TYPES 31 H - 61 H

Type 31H

Type 61H

1 dia. Ø 4,8 stud shells 07 to 19  
1 dia. Ø 5,8 stud shells 27 to 121

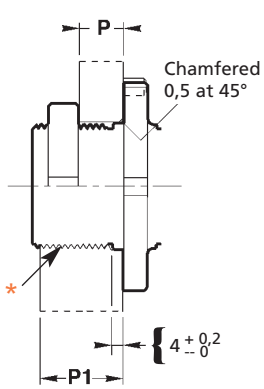
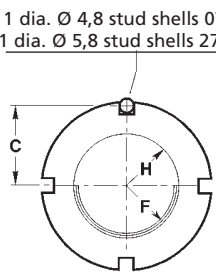

Assembly in smooth hole  
(not EExd)

Assembly in tapped hole  
(EExd)

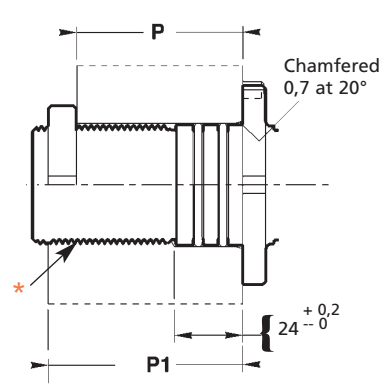

\* EExd : ISO thread, F class, H6, 8 mm minimum.

Shell	Assembly in smooth hole (Not EExd)		Assembly in tapped hole
	P max.	P mini.	P1 max.
9316-31 H	20	5	-
9316-61 H **	60	25	70
9316-61 H 121	50	25	60

Size	C $\pm 0,2$	F	Pich ***	H $+0$ $-0,2$	Tightening torque mN
07	24,50	29	150	30,30	70
12	25,00	31	150	32,30	75
19	26,50	34	150	35,30	80
27	33,00	41	200	42,30	90
37	35,50	46	200	47,30	100
61	38,50	53	200	54,30	120
121	46,00	67	250	68,30	145

Thermo-shrink sleeve

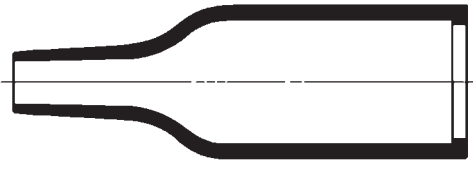

Size	Sleeve reference
07	086-0104-06
12	086-0104-06
19	086-0104-06
27	086-0104-07
37	086-0104-07
61	086-0104-08
121	086-0104-08

Gaskets and counter - Gasket for shell and accessories

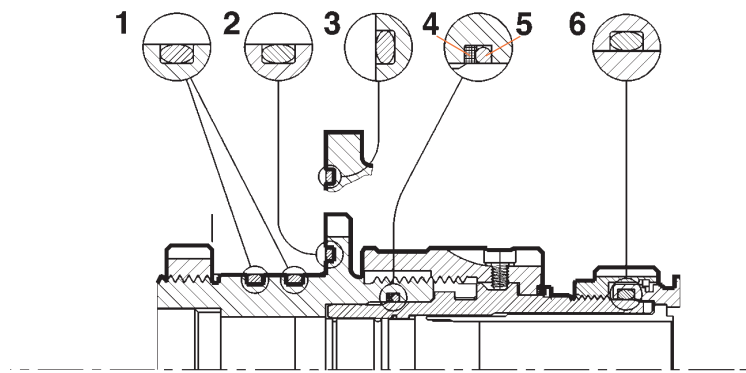

Size	1 O'ring for Type 61 H	2 O'ring for Types 31-61 H	3 O'ring for Type 25 H	3 O'ring for Type 51 H	4 Counter-gasket for receptacles	5 O'ring for receptacles	6 O'ring for accessory stainless
07	103-0003-20-A817	103-0003-25-A817	103-0003-19-A817	103-0003-19-A817	103-0021-16	103-0003-16-A010	103-0003-17-A817
12	103-0003-21-A817	103-0003-26-A817	103-0003-20-A817	103-0003-20-A817	103-0021-17	103-0003-17-A010	103-0003-19-A817
19	103-0003-23-A817	103-0003-28-A817	103-0003-22-A817	103-0003-22-A817	103-0021-19	103-0003-19-A010	103-0003-21-A817
27	103-0003-28-A817	103-0003-34-A817	103-0003-25-A817	103-0003-25-A817	103-0021-23	103-0003-23-A010	103-0003-24-A817
37	103-0003-31-A817	103-0003-37-A817	103-0003-27-A817	103-0003-27-A817	103-0021-26	103-0003-26-A010	103-0003-26-A817
61	103-0003-35-A817	103-0003-41-A817	103-0003-33-A817	103-0003-33-A817	103-0021-30	103-0003-30-A010	103-0003-31-A817
121	103-0003-44-A817	103-0003-50-A817	103-0003-42-A817	103-0009-30-A817	103-0021-38	103-0003-38-A010	103-0003-38-A817

DEUTSCH recommends :  
On hermetic or standard receptacles, lubrication of the coupling O'rings (inside the receptacles) after about 50 mating/unmating operations. We recommend silicon grease.

CONTACTS

CABLE



# contacts	Index	Reference	Type	Crimp barrel Ø mini.	AWG wire	Section mm <sup>2</sup>	Ø sheath
20	without	047-0894-20 047-0893-20	P S	1,30	18 to 24	0,22 to 0,93	1,52 to 2,54
	*	047-1022-20 047-1023-20	P S	0,49	26 to 30	0,055 to 0,15	
	*	047-1024-20 047-1025-20	P S	2,50	16 to 18	0,93 to 1,34	
16	without	047-0894-16 047-0893-16	P S	1,68	16 to 18	0,93 to 1,34	2,66 to 3,42
	*	047-1022-16 047-1023-16	P S	1,30	18 to 24	0,22 to 0,93	
	*	047-1024-16 047-1025-16	P S	2,17	12 to 14	1,91 to 3,18	
12	without	047-0894-12 047-0893-12	P S	2,52	12 to 14	1,91 to 3,18	3,80 to 4,95
	*	047-1022-12 047-1023-12	P S	1,30	18 to 24	0,22 to 0,93	
	*	047-1024-12 047-1025-12	P S	1,96	14 to 18	0,93 to 1,91	
8	8	047-0894-08 047-0893-08	P S	4,70	8	10	4,30 to 5,50
	87	047-1329-08 047-1330-08	P S	3,46	10	5,30	
	88	047-1325-08 047-1326-08	P S	4,52	8	8,98	

● Standard contacts supplied with the connector

\* : Special contacts, to be ordered separately

■ Coaxial contacts and tooling

Please, consult us





**FILLER PLUGS**

**CRIMPING TOOL**

**INSERTION TOOL**

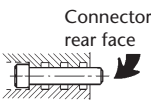
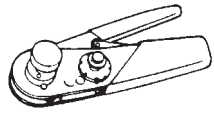
**EXTRACTION TOOL**

 <p>Connector rear face</p>			 <p>Rear insertion tool</p>	 <p>Front insertion tool</p>
Reference	Reference	Reference Locator	Reference	Reference
006-0893-20	057-0461-11	057-0503-21	057-0473-60	057-0479-60
	057-0463-12	057-0591-32		
	057-0461-11	057-0503-21		
092-1057-16	057-0461-11	057-0503-21	057-0472-60 057-0473-60 057-0471-60	057-0478-60
092-1056-12	057-0461-11	057-0503-21	057-0471-60	057-0477-60
			057-0473-60	
			057-0472-60	
047-1052-08	Solder		057-0474-60	057-0480-60
	057-0585-11			





**INOGIA**  
DISTRIBUTION

E-mail : [info@inogia.com](mailto:info@inogia.com) - Tel. : +33 1 34 61 80 84

[www.inogia.com](http://www.inogia.com)